

## **The LED Store Rugby Pitch 110m x 69m Sample Area - 75lux**

CAUTION: The performed design & lux level calculation has been carried out using the specified luminaires & layouts - any deviations to product and/or layout will result in variations in the lux levels and overall lighting scheme and could affect compliance.

Date: 20.11.2020  
Operator: The LED Store

Operator The LED Store  
Telephone 03333 444 943  
Fax 03333 444 943  
e-Mail [sales@theledstore.co](mailto:sales@theledstore.co)

## Table of contents

<b>The LED Store Rugby Pitch 110m x 69m Sample Area - 75lux</b>	
Project Cover	1
Table of contents	2
<b>The LED Store LSTHM-300-30X30 300W LED HIGH MAST SPORTS PITCH TENNI...</b>	
Luminaire Data Sheet	3
<b>Rugby Pitch</b>	
Planning data	4
Luminaire parts list	5
3D Rendering	6
False Colour Rendering	7
<b>Exterior Surfaces</b>	
<b>Calculation Grid</b>	
Value Chart (E, Perpendicular)	8

Operator The LED Store  
Telephone 03333 444 943  
Fax 03333 444 943  
e-Mail [sales@theledstore.co](mailto:sales@theledstore.co)

## The LED Store LSTHM-300-30X30 300W LED HIGH MAST SPORTS PITCH TENNIS COURT STADIUM ARENA LIGHT 30x30Degree Beam Angle / Luminaire Data Sheet

See our luminaire catalog for an image of the luminaire.



Luminaire classification according to CIE: 100  
CIE flux code: 84 90 96 100 100

Luminous emittance 1:

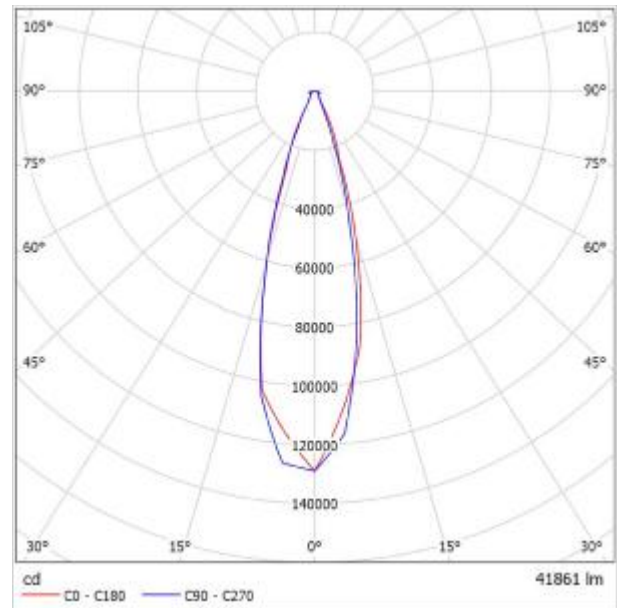

Due to missing symmetry properties, no UGR table can be displayed for this luminaire.

Operator The LED Store  
 Telephone 03333 444 943  
 Fax 03333 444 943  
 e-Mail sales@theledstore.co

**Rugby Pitch / Planning data**

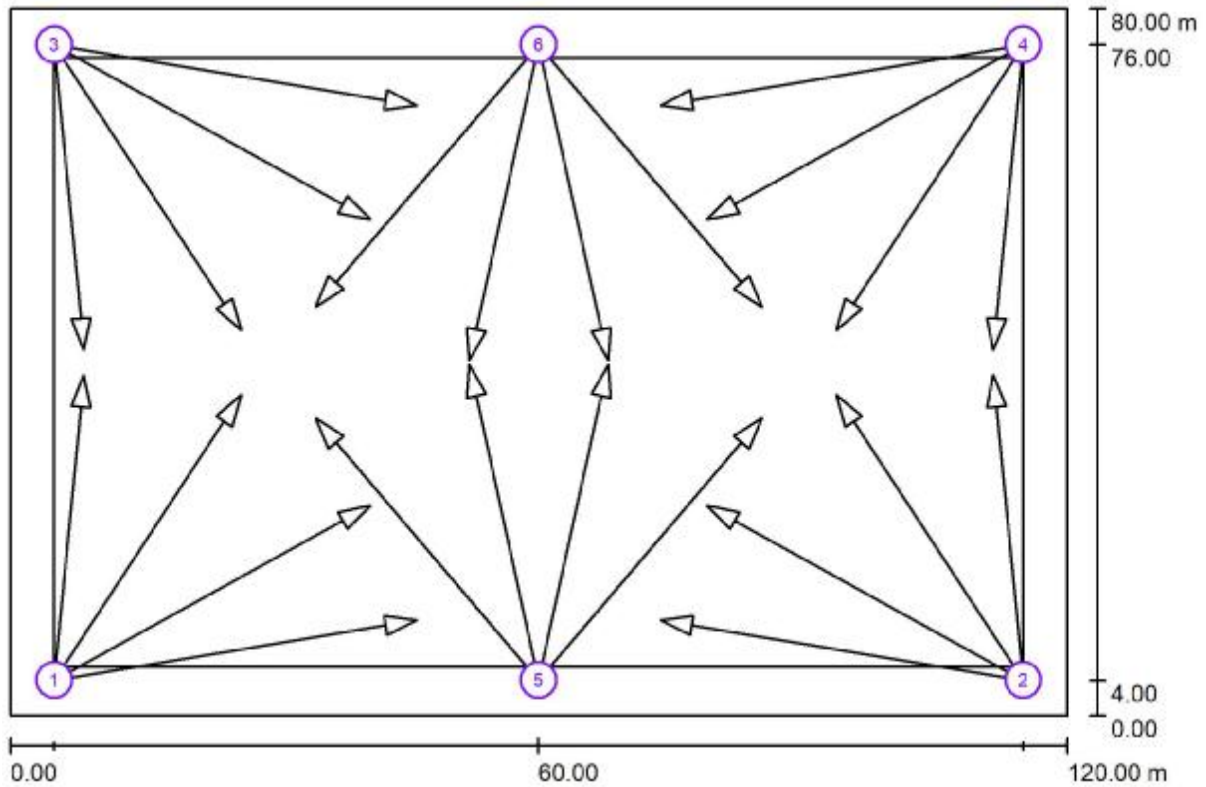

Maintenance factor: 0.80, Mounting Height: 10.000m, ULR (Upward Light Ratio): 15.5%

Scale 1:858

**Luminaire Parts List**

No.	Pieces	Designation (Correction Factor)	Φ (Luminaire) [lm]	Φ (Lamps) [lm]	P [W]
1	24	The LED Store LSTHM-300-30X30 300W LED HIGH MAST SPORTS PITCH TENNIS COURT STADIUM ARENA LIGHT 30x30Degree Beam Angle (1.000)	41861	41861	308.4
Total:			1004668	Total: 1004668	7401.6

Operator The LED Store  
Telephone 03333 444 943  
Fax 03333 444 943  
e-Mail [sales@theledstore.co](mailto:sales@theledstore.co)

## Rugby Pitch / Luminaire parts list

24 Pieces The LED Store LSTHM-300-30X30 300W LED HIGH MAST SPORTS PITCH TENNIS COURT STADIUM ARENA LIGHT 30x30Degree Beam Angle  
Article No.: LSTHM-300-30X30  
Luminous flux (Luminaire): 41861 lm  
Luminous flux (Lamps): 41861 lm  
Luminaire Wattage: 308.4 W  
Luminaire classification according to CIE: 100  
CIE flux code: 84 90 96 100 100  
Fitting: 1 x LSTHM-300-30X30 (Correction Factor 1.000).

See our luminaire catalog for an image of the luminaire.

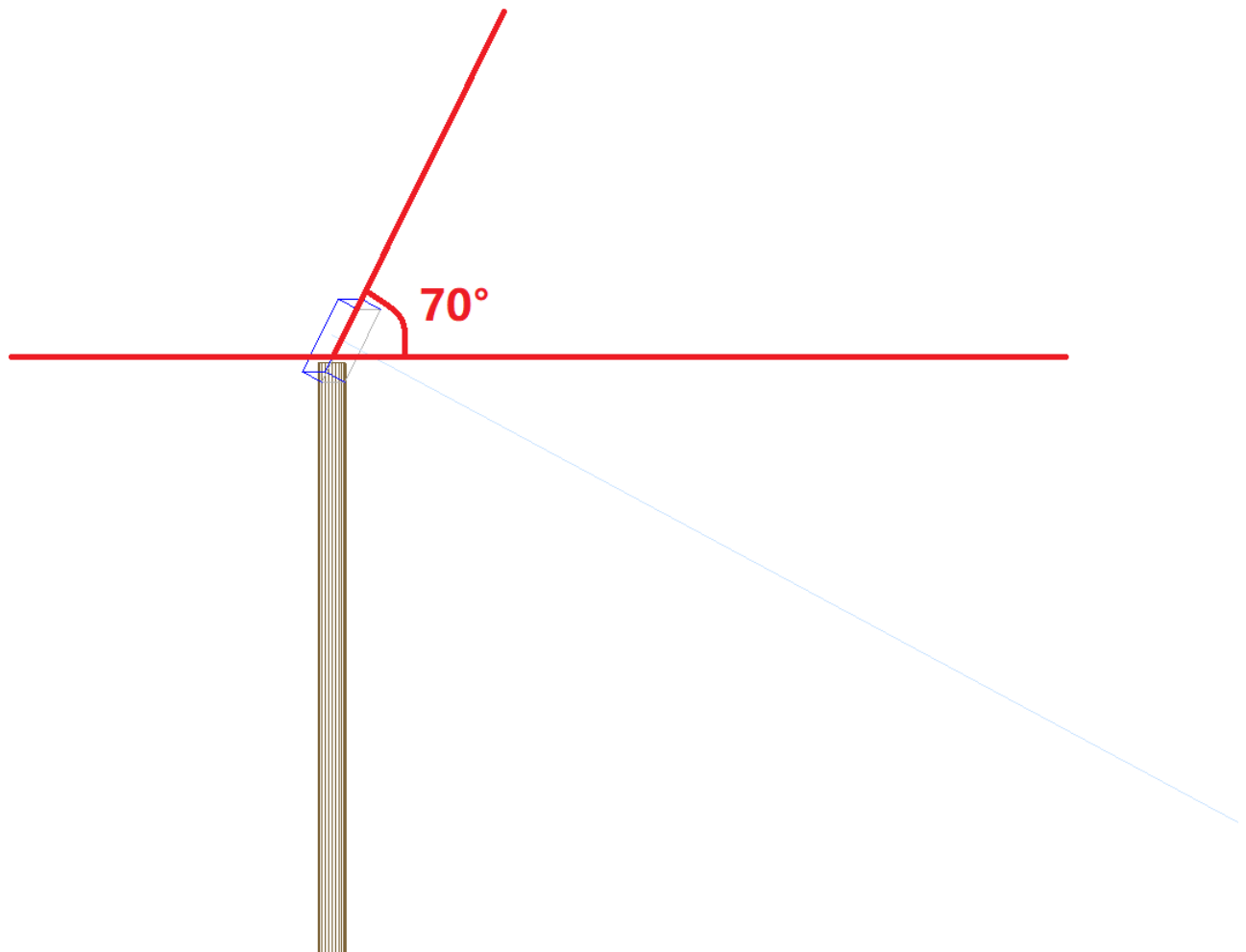
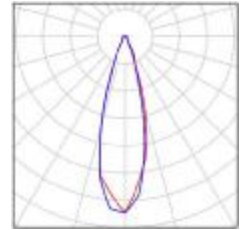

Operator The LED Store  
Telephone 03333 444 943  
Fax 03333 444 943  
e-Mail [sales@theledstore.co](mailto:sales@theledstore.co)

## Rugby Pitch / 3D Rendering

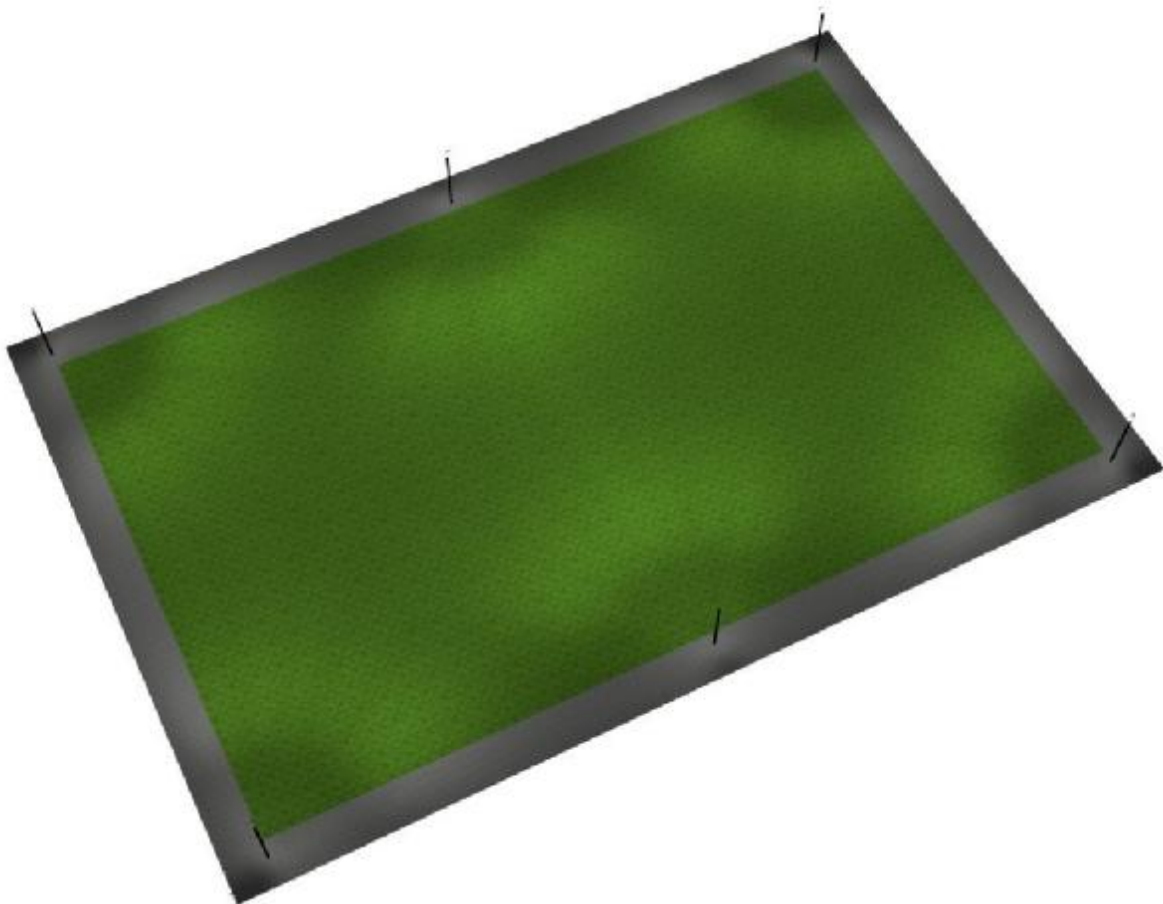

Operator The LED Store  
Telephone 03333 444 943  
Fax 03333 444 943  
e-Mail [sales@theledstore.co](mailto:sales@theledstore.co)

### Rugby Pitch / False Colour Rendering

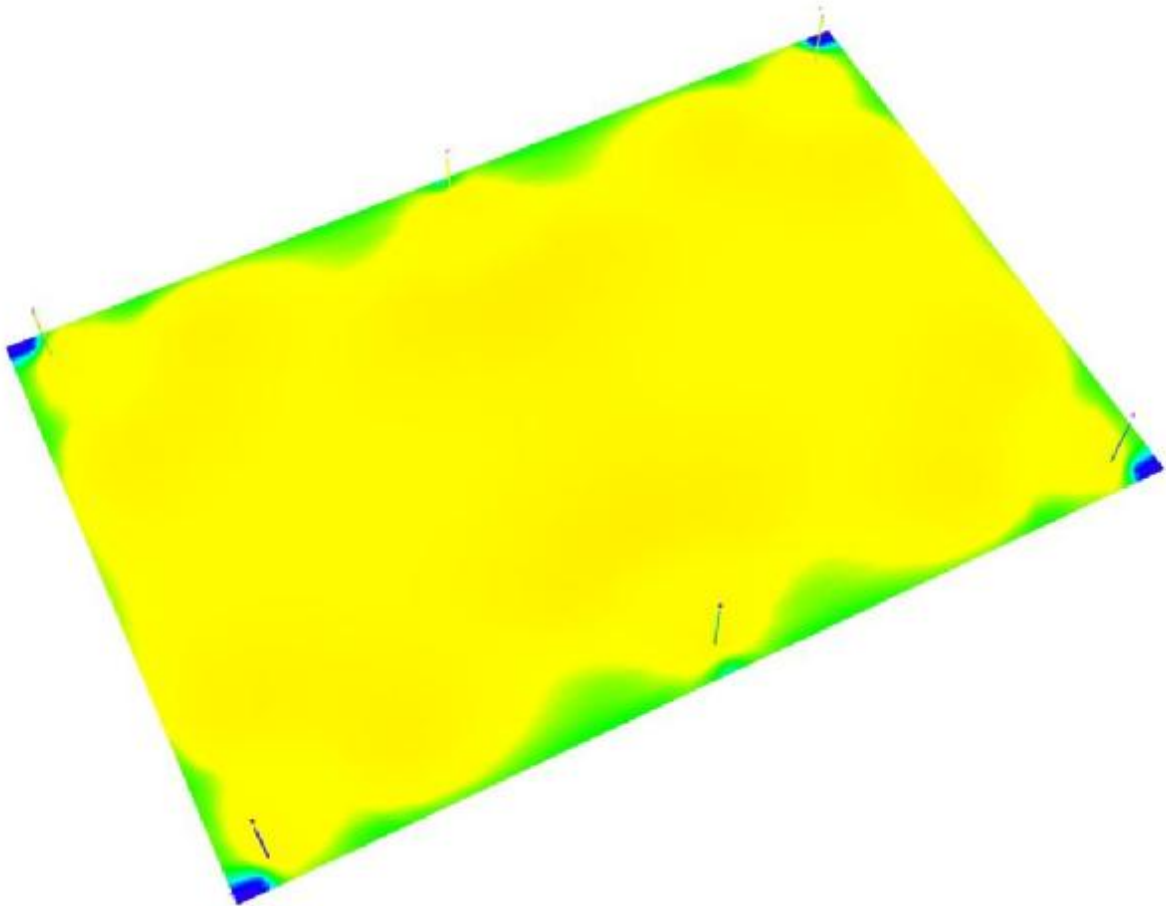

0 1 5 25 50 75 150 300 600 lx

Operator The LED Store  
 Telephone 03333 444 943  
 Fax 03333 444 943  
 e-Mail sales@theledstore.co

### Rugby Pitch / Calculation Grid / Value Chart (E, Perpendicular)

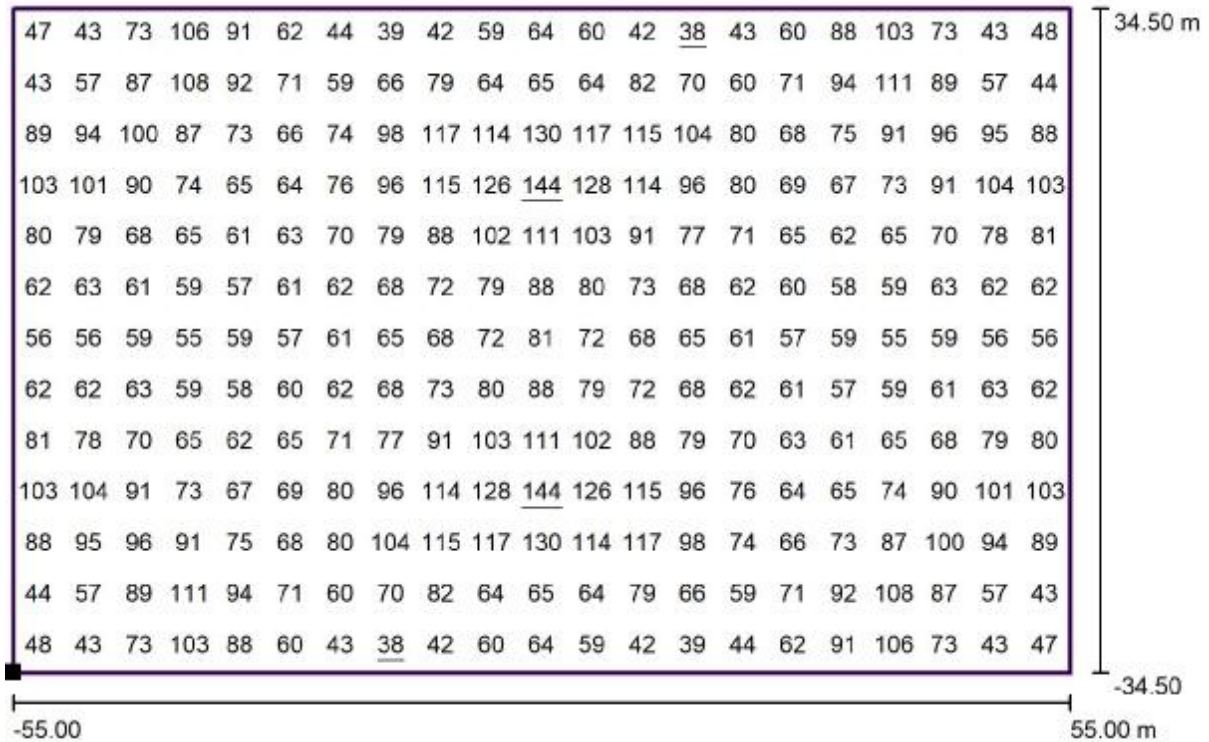

Values in Lux, Scale 1 : 787

Position of surface in external scene:  
 Marked point: (5.000 m, 5.500 m, 0.000 m)



Grid: 21 x 13 Points

$E_{av}$  [lx]  
76

$E_{min}$  [lx]  
38

$E_{max}$  [lx]  
144

$u_0$   
0.50

$E_{min} / E_{max}$   
0.27